

31 584 SD1 K800 STAINLESS STEEL SINK

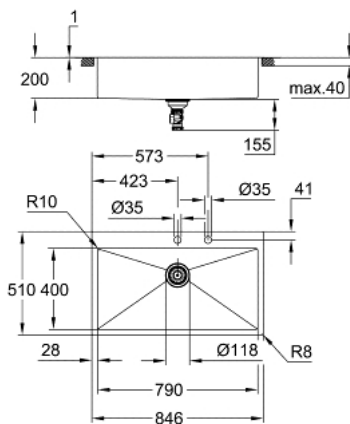

TOOTE KIRJELDUS

- Värvus: stainless steel
- model: K800 90-S 84.6/51 1.0
- mounting type: top mount or flush mount
- material: stainless steel AISI 304 (V2A)
- material thickness: 1 mm
- GROHE LongLife finish
- finish: satin finish
- GROHE Whisper
- min. cabinet size: 900 mm
- dimensions: 846 x 510 mm
- 1 bowl: 790 x 400 x 200 mm
- outer radius: R3, inner bowl radius: R10
- GROHE FastFixation installation system
- cut-out (top mount): 831 x 495 mm (R3)
- cut-out (flush mount): 831 x 495 mm (R3) (top step outer size: -847 x 511 -R8 deep -3.5 mm)
- waste: Ø 3.5"/90 mm waste strainer with automatic waste fitting
- accessories included: automatic waste fitting with rotary handle, waste kit, basket strainer waste, mounting set
- optional push to open excenter (40 986 SD0)
- amount of fasteners included (top mount): 10

31 584 SD1 K800 STAINLESS STEEL SINK

VARUOSAD, oktoober 2019 – nüüd

1: Plug (Tellimuse number 42588SD0)

2: Turning handle (Tellimuse number 42586SD0)

3: Cover element (Tellimuse number 42590SD0)

